

**MODELS COVERED:
SAL500-INDR**



For assistance please contact ILS Products

customer service 1 877 675 9762
sales@globalils.com
www.globalils.com

DATE: DEC 2022

REVISION : 01

**RANCH HAND
INSTALLATION**

**PLEASE ALLOW 2 DAYS FOR
SOLAR LIGHT TO FULLY CHARGE
BEFORE POWERING ON**

General Guidelines

- Please read the following instruction carefully and use the product accordingly.
- This summary may not include every detail of all variations and considered steps. Please contact us when further information and help are needed.

Notes

- It is recommended that two adults assemble the product. Please assemble this item strictly according to each step in the instructions.
- During assembly, first loosely fit all components then tighten them when instructed.
- Keep the product away from corrosive chemicals to prevent damage to the surfaces.
- Periodically inspect and clean the fixtures solar panel and LED's.

Warnings

- During assembly, keep all small parts out of the reach of children. It may be fatal if swallowed or inhaled.
- Children are not allowed to climb on the product to avoid personal injury caused by the product tilting or tipping over.
- Please do not use the product if there is/are defective and/or missing parts, as this can result in damage or injury.
- To avoid the potential dangers of suffocation, please keep all parts and packaging (film, plastic bags, foam, etc.) away from babies and children.
- The product should be attached with the included hardware kits.

Tools Required

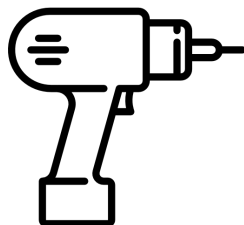

X 1



500 watt Solar Light with

X 1



Solar Panel—includes 8 ft cable

X 1



Hardware and Remote

X 1

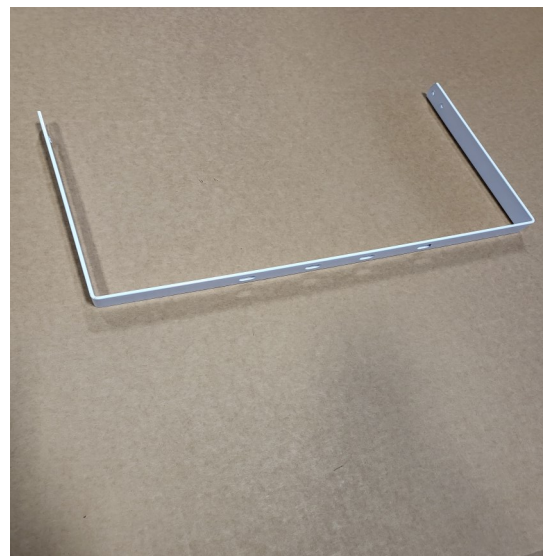

Solar Panel Bracket

1

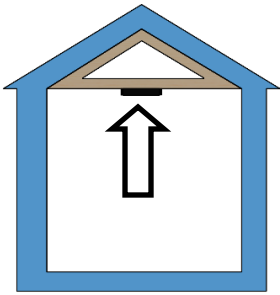

Install Solar Light onto suitable structure of the building

2

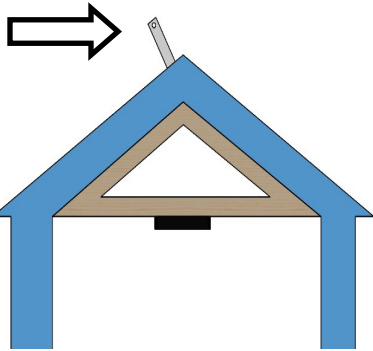

Install the Solar Panel Bracket onto the top of the Roof. (Keep in mind to point as south as possible)

3

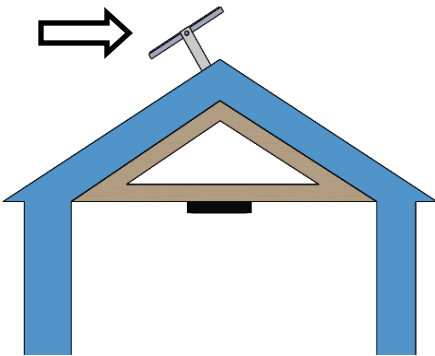

Install the Solar Panel onto the bracket with supplied hardware.

4

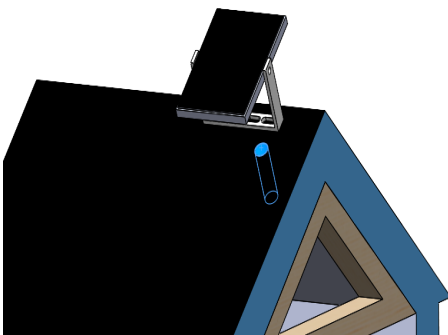

Drill a 5/8" hole through the roof. We recommend to drill under the panel to provide extra protection from weather.

5

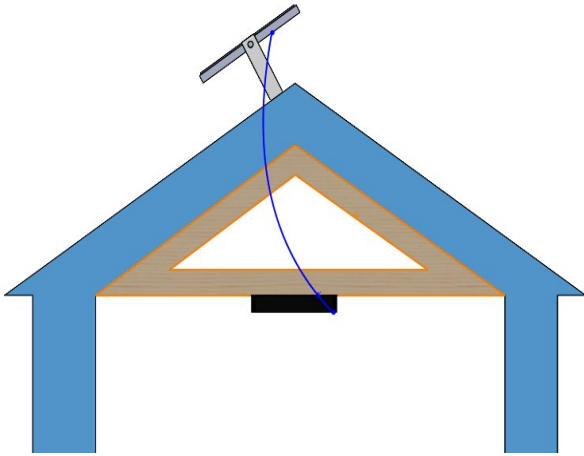

Connect the cable from the Panel to the Solar light. Make sure to fill the hole with silicone or other suitable Roof weatherproofing.

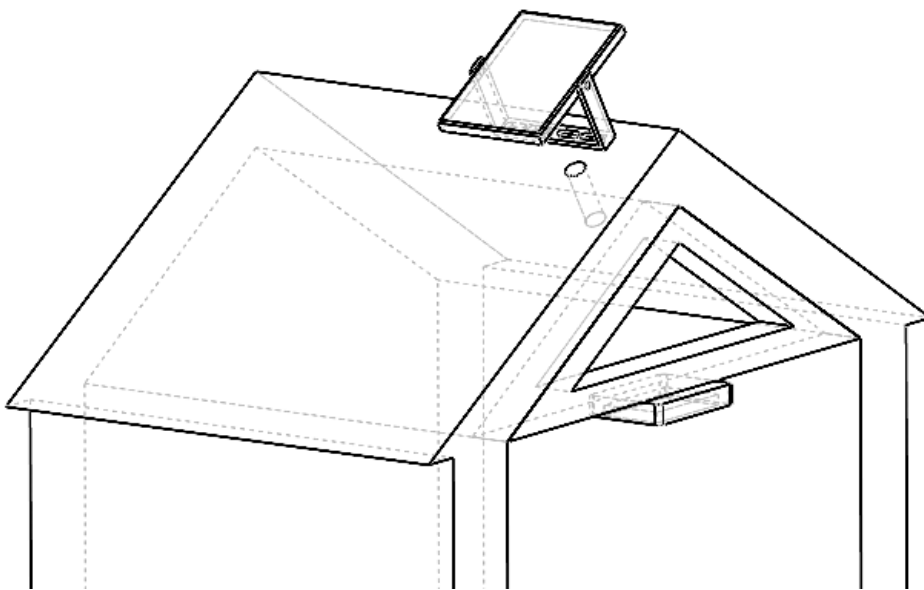

MODELS COVERED: Ranch Hand



For assistance please contact ILS
Products customer service 979-421-9022
sales@globalils.com
www.globalils.com

DATE: March 2023

REVISION : 002

Remote Operation

General Guidelines

- Please read the following instruction carefully and use the product accordingly.
- This summary may not include every detail of all variations and considered steps.
- Please contact us when further information and help are needed.

YOUR RANCH HAND SOLAR LIGHTING SYSTEM LIGHT IS AN AUTO DUSK TO DAWN LIGHT. YOU ARE ABLE TO USE THE REMOTE TO TURN IT OFF *DAILY*. YOU CAN ALSO PRESS THE HARD ON/OFF BUTTON ON THE LIGHT FIXTURE ITSELF, YOU WILL NEED TO PRESS THAT BUTTON AGAIN FOR THE LIGHT TO FUNCTION FOR NEXT USE.

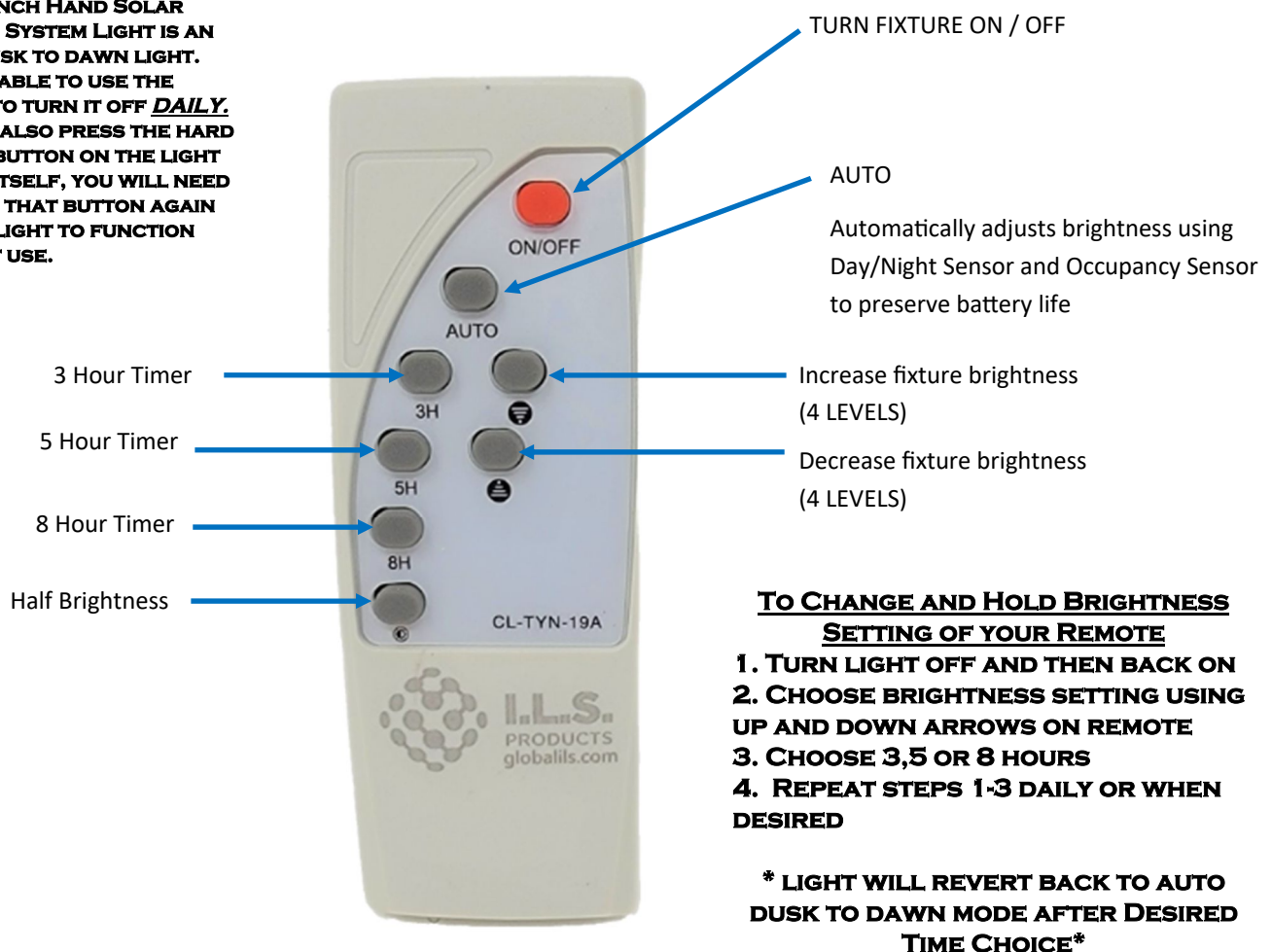



WARRANTIES AND RETURNS

WARRANTIES: All ILS Products LLC Solar Area Lights, Corner Casting Adapter, Brackets (excluding nuts, bolts, washers), and poles are warranted by ILS PRODUCTS LLC to be free from defects in material and workmanship for One (1) year from the date of shipment.

All packages must be opened by the customer within 14 days of receipt to check for damage occurring during transit for warranty to be applicable as follows: THIS WARRANTY DOES NOT APPLY TO EQUIPMENT OR GOODS WHICH ARE MISUSED, OR ABUSED, OR DAMAGED FROM INSTALLATION, OR NOT USED IN ACCORDANCE WITH ILS PRODUCTS LLC'S INSTRUCTIONS. NORMAL WEAR OF EQUIPMENT OR GOODS IS NOT INCLUDED IN THIS WARRANTY. ILS PRODUCTS LLC'S SOLE LIABILITY UNDER THIS WARRANTY SHALL BE LIMITED TO EITHER REPLACING OR REPAIRING WITHOUT CHARGE, AT ITS FACTORY OR ELSEWHERE AT ITS DISCRETION, ANY EQUIPMENT OR GOODS NOT MEETING THIS WARRANTY, OR AT ILS PRODUCTS LLC'S OPTION, REFUNDING THE PURCHASE PRICE. ILS PRODUCTS LLC SHALL IN NO EVENT BE LIABLE FOR ANY OTHER DIRECT OR ANY SPECIAL INDIRECT OR CONSEQUENTIAL DAMAGES OF ANY KIND UNDER THIS CONTRACT OR OTHERWISE.

ILS Products LLC makes no warranty about the actual grade of steel or its material components other than the representations made to ILS PRODUCTS LLC from its suppliers. ILS PRODUCTS LLC will use its best efforts to ensure that all products are inspected for open and obvious defects including dents, severe pitting, malformations, or alterations and will avoid use of such material.

WARRANTY PROCEDURE: Customers who have a warranty claim will need to either provide photo/ video evidence of defect or malfunction for ILS Products warranty records. Customers may also send warranty items back to ILS Products for repairs or replacement. ILS Products will review or inspect warranty claim items within 10 days. If no warranty covered issue is found, warranty claim will be denied. If issue is found, customer will receive replacement item(s) with tracking information and a return label (if applicable) for return of defective item(s).

PRODUCT RETURN POLICY & PROCEDURE: Seller shall accept returns of normal stock Goods for a period of thirty (30) days following shipment delivery for exchange or refund of the purchase price less the shipping fees ***provided that Goods are in their original cartons, unopened and unused and a return has been authorized by Seller.*** Returns that are used, opened, and/or not in their original packaging may be subject to a minimum 50% restocking fee or the return may be refused based on the condition of the returned material with the exception of manufacturing defects. Applicable sales tax will be refunded where allowed by applicable law or statute. International Product returns are at the discretion of the seller and may incur additional costs as the seller deems necessary. International Refunds will not be issued prior to 60 days after Seller receives the returned goods and has inspected such goods to ensure they meet the fore mentioned terms.

Customer is solely responsible for shipping any returned product to ILS Products, LLC, Customer agrees to use only reputable carriers capable of providing proof of delivery and insurance for the entire value of the shipment. Customer agrees to bear all shipping and insurance charges and all risk of loss for the return product during shipment. Customer agrees that all returned products will be 100% complete, unused in re-saleable condition, and will include the original undamaged packaging material, manuals, blank warranty cards, and other accessories provided by the manufacturer. If any component of the returned product is missing, or if the product has been used ILS Products, LLC, Return Procedure will be breached and ILS Products, LLC, may in its sole and absolute discretion reject the entire return or choose to impose additional charges against the customer for replacement of the missing component(s). If you return an order that has shipped to you under a free shipping offer you will be charged actual shipping charges incurred by ILS Products, LLC to ship your order. ILS Products, LLC will not refund to Customer the original shipping charges OR original service fees charged by the credit card processing merchant. Any returns made after the 30 day return window will also incur a 50% restocking fee at the sole discretion of ILS Products LLC.

Any wholesale, resale, trade or volume orders over \$2000 in value or more than 10 items are not eligible for return & are covered by Trade, Wholesale Distributor warranty if applicable.

PHYSICAL DAMAGE: Physical damage to any product purchased from ILS PRODUCTS, LLC will void our Return Policy & Warranty Coverage provided. Physical damage includes but is not limited to improper handling, installation and/or any other type of damage sustained by irregular use.